

SILENTA-BOX

Black Orchid Silenta-box with UK Plug

The Silenta-box is an In-line metal box fan. The centrifugal impeller and Blauberg motor are enclosed within a galvanized steel casing filled with 30mm thermal and sound insulating, non-flammable foam for systems that require low noise levels.

Silenta-box features a 2 pole motor that is equipped with ball bearings for a longer service life. The motor is installed on purpose built vibration-damping mounts to absorb vibration and noise. The centrifugal impeller with backward curved blades is dynamically balanced to ensure high airflow levels against resistances caused by long duct runs and carbon filters.

Ideal for supply or extract ventilation, Silenta-box can be controlled by an external speed controller.



Air flow:
up to 2150 m³/h



Power:
from 72 W



Noise level:
from 33 dBa

DESIGN

- Supplied with 1.8m power cable and fitted UK or EU plug.
- Ideal for systems with high levels of resistance that also require quiet operation.
- Protection rating IPX4 and equipped with overheating protection.
- Blauberg German Motor.
- Five year Black Orchid warranty.
- Mounting brackets included.

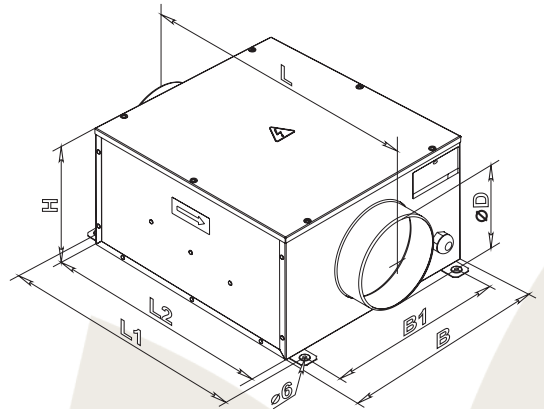

PERFORMANCE

Product	Description	Air Flow (m ³ /h)	Power (W)	Noise Level (dBa)
BO-SB-100-UK	Black Orchid Silenta-box in-line fan 4" Dia c/w UK plug & Lead	240	73	33
BO-SB-125-UK	Black Orchid Silenta-box in-line fan 5" Dia c/w UK plug & Lead	330	73	35
BO-SB-150-UK	Black Orchid Silenta-box in-line fan 6" Dia c/w UK plug & Lead	420	72	36
BO-SB-200-UK	Black Orchid Silenta-box in-line fan 8" Dia c/w UK plug & Lead	730	103	38
BO-SB-200-MAX-UK	Black Orchid Silenta-box in-line fan 8" Dia c/w UK Plug & Lead	950	195	45
BO-SB-250-UK	Black Orchid Silenta-box in-line fan 10" Dia c/w UK plug & Lead	1300	198	41
BO-SB-315-UK	Black Orchid Silenta-box in-line fan 12" Dia c/w UK plug & Lead	2150	322	43

DIMENSIONS [MM]

Product	ØD	B	B1	H	L	L1	L2	Weight [kg]
BO-SB-100-UK	99	322	280	192	447	380	350	5.4
BO-SB-125-UK	124	322	280	192	447	380	350	5.4
BO-SB-150-UK	149	352	310	212	477	410	380	6.4
BO-SB-200-UK	199	432	368	287	588	506	480	10
BO-SB-200-MAX-UK	199	432	368	287	588	506	480	12.0
BO-SB-250-UK	249	432	368	287	588	506	480	12.5
BO-SB-315-UK	314	502	438	397	648	566	540	15.5

PERFORMANCE GRAPHS

BO-SB-100-UK

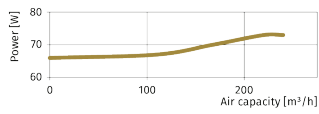
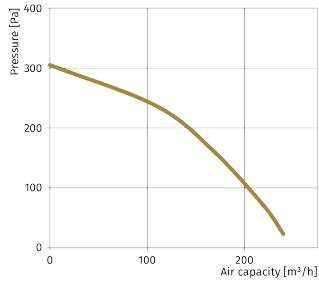

BO-SB-125-UK

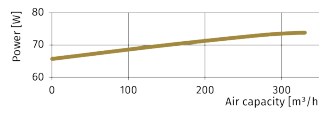
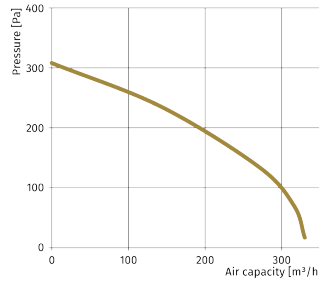

BO-SB-150-UK

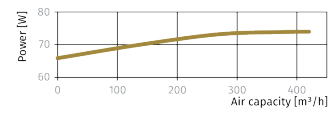
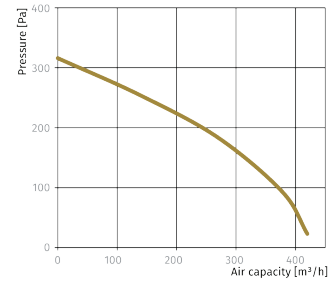

BO-SB-200-UK

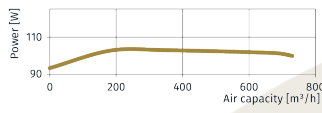
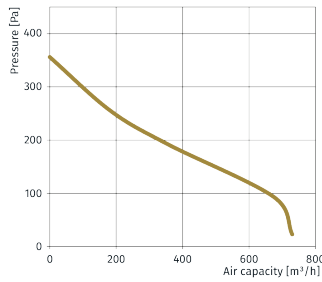

BO-SB-250-UK

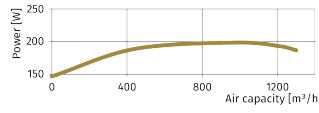
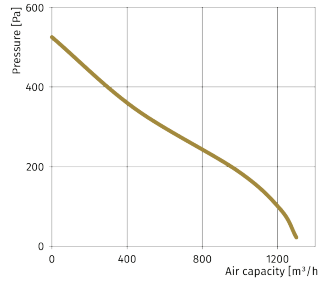

BO-SB-315-UK

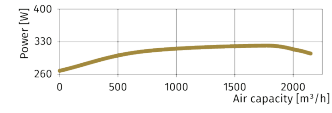
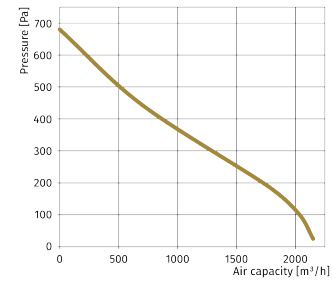

BO-SB-200-MAX-UK

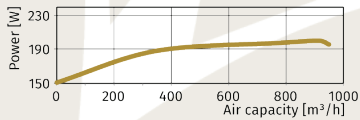
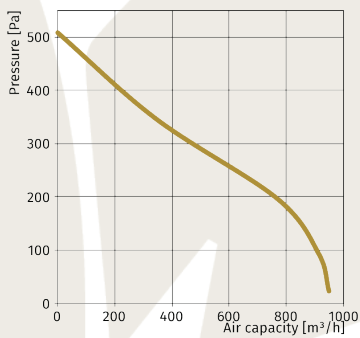

ACCESSORIES

