

## CENTRI-FLO TWIN

### Black Orchid Centri-flo Fan with a 2 speed switch

The Black Orchid Centri-flo Twin features an in-built 2 speed switch, aerodynamically shaped casing and centrifugal impeller enables higher volumes of air to be moved against resistance caused by carbon filters and long duct runs.

The built-in 2 speed switch allows the user to set the fan to a low or high speed, this does not affect the fan's ability to be connected to an external speed controller.

Centri-flo is also supplied with detachable mounting brackets for wall, ceiling or floor mounting. Also, for 2018 we will be launching a tent mounting bracket.



**Air flow:**  
up to 1340 m<sup>3</sup>/h



**Power:**  
from 41 W



**Noise level:**  
from 46 dBa

### DESIGN

- Two Speed Switch
- Supplied with 1.8m power cable and fitted UK or EU plug.
- Single-phase external rotor motor with a centrifugal impeller with backward curved blades.
- Includes mounting brackets.
- Protection rating IPX4 and equipped with overheating protection.
- Blauberg German Motor.
- Five year Black Orchid warranty.

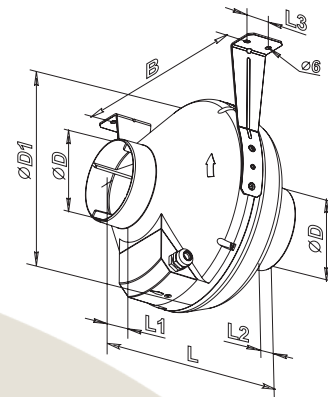

### PERFORMANCE

Product	Description	Air Flow [m <sup>3</sup> /h]		Power [W]		Noise Level [dBa]	
		min	max	min	max	min	max
BO-CF-100-TWIN-UK	Twin Speed Fan 4" Dia Twin Speed c/w UK Plug & Lead	195	250	41	80	46	46
BO-CF-125-TWIN-UK	Twin Speed Fan 5" Dia Twin Speed c/w UK Plug & Lead	250	355	43	80	46	46
BO-CF-150-TWIN-UK	Twin Speed Fan 6" Dia Twin Speed c/w UK Plug & Lead	360	460	43	80	46	46
BO-CF-200-TWIN-UK	Twin Speed Fan 8" Dia Twin Speed c/w UK Plug & Lead	645	780	90	102	48	48
BO-CF-250-TWIN-UK	Twin Speed Fan 10" Dia Twin Speed c/w UK Plug & Lead	850	1080	130	167	50	50
BO-CF-315-TWIN-UK	Twin Speed Fan 12" Dia Twin Speed c/w UK Plug & Lead	1005	1340	105	188	50	50

### DIMENSIONS [MM]

Product	ØD	ØD1	B	L	L1	L2	L3	Weight [kg]
BO-CF-100-TWIN-UK	100	250	270	230	30	27	30	2.01
BO-CF-125-TWIN-UK	125	250	270	220	30	27	30	2.2
BO-CF-150-TWIN-UK	150	300	310	286	30	30	30	2.45
BO-CF-200-TWIN-UK	200	340	354	276	30	30	40	3
BO-CF-250-TWIN-UK	250	340	354	265	30	30	40	4.3
BO-CF-315-TWIN-UK	315	400	414	276	40	55	40	4.85

PERFORMANCE GRAPHS

BO-CF-100-TWIN-UK

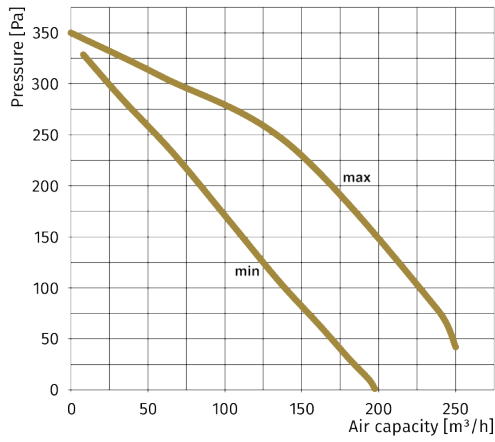

BO-CF-125-TWIN- UK

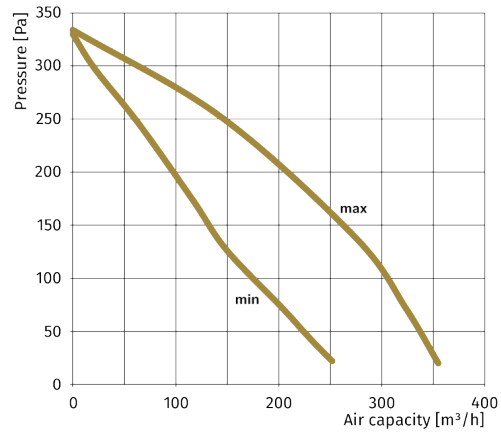

BO-CF-150-TWIN- UK

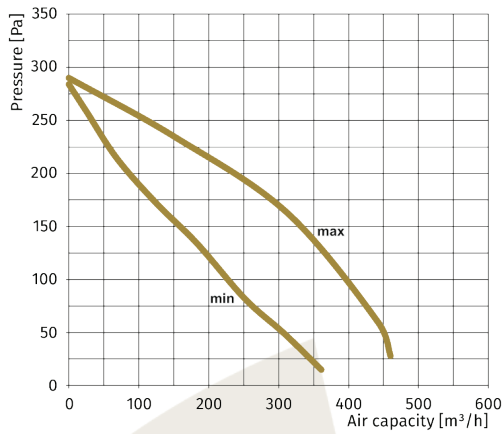

BO-CF-200-TWIN- UK

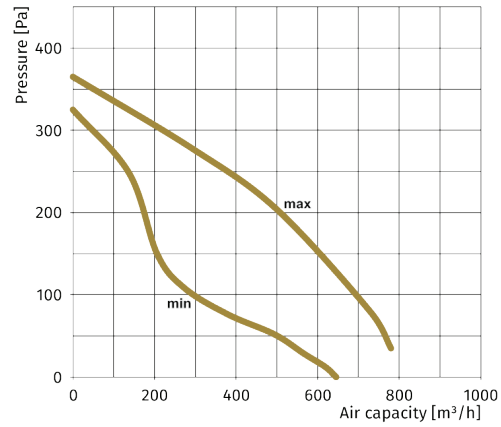

BO-CF-250-TWIN- UK

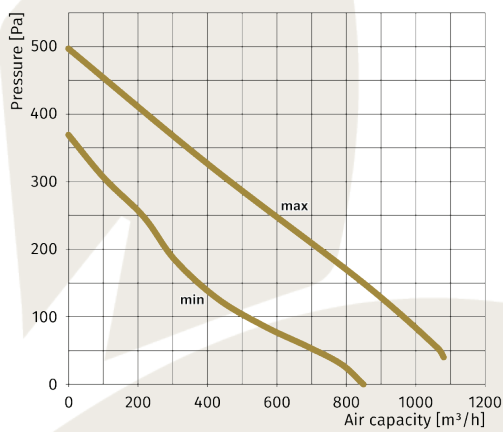

BO-CF-315-TWIN- UK

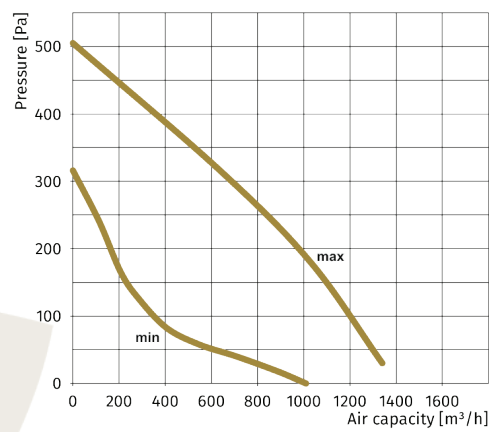

ACCESSORIES

