

CENTRI-FLO

Black Orchid Centri-flo fan with UK plug

The Black Orchid Centri-flo is the ideal 'plug and play' unit. The aerodynamically shaped casing and centrifugal impeller enables higher volumes of air to be moved against resistance caused by carbon filters and long duct runs.

Compatible with an external speed controller for full and smooth speed control.

Centri-flo is also supplied with detachable mounting brackets for wall, ceiling or floor mounting. Also, for 2018 we will be launching a tent mounting bracket.



Air flow:
up to 1700 m³/h



Power:
from 80 W



Noise level:
from 46 dBa

DESIGN

- Supplied with 1.8m power cable and fitted UK or EU plug.
- Single-phase external rotor motor with a centrifugal impeller with backward curved blades.
- Includes mounting brackets.
- Protection rating IPX4 and equipped with overheating protection.
- Blauberg German Motor.
- Five year Black Orchid warranty.

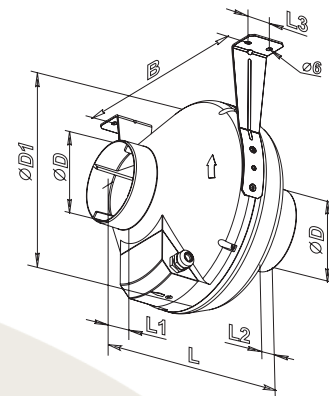

PERFORMANCE

Product	Description	Air Flow [m ³ /h]	Power [w]	Noise Level [dba]
BO-CF-100-UK	Black Orchid Centri-flo Fan 4" Dia c/w UK Plug & Lead	250	80	46
BO-CF-125-UK	Black Orchid Centri-flo Fan 5" Dia c/w UK Plug & Lead	355	80	46
BO-CF-150-UK	Black Orchid Centri-flo Fan 6" Dia c/w UK Plug & Lead	460	80	46
BO-CF-200-UK	Black Orchid Centri-flo Fan 8" Dia c/w UK Plug & Lead	780	107	48
BO-CF-200-MAX-UK	Black Orchid Centri-flo Fan 8" Dia c/w UK Plug & Lead	930	173	51
BO-CF-250-UK	Black Orchid Centri-flo Fan 10" Dia c/w UK Plug & Lead	1080	173	50
BO-CF-315-UK	Black Orchid Centri-flo Fan 12" Dia c/w UK Plug & Lead	1340	200	50
BO-CF-315-MAX-UK	Black Orchid Centri-flo Fan 12" Dia c/w UK plug & Lead	1700	310	53

DIMENSIONS [MM]

Product	ØD	ØD1	B	L	L1	L2	L3	Weight [kg]
BO-CF-100-UK	100	250	270	230	30	27	30	2.01
BO-CF-125-UK	125	250	270	220	30	27	30	2.2
BO-CF-150-UK	150	300	310	286	30	30	30	2.45
BO-CF-200-UK	200	340	354	276	30	30	40	3
BO-CF-200-MAX-UK	200	340	354	276	30	30	40	3
BO-CF-250-UK	250	340	354	265	30	30	40	4.3
BO-CF-315-UK	315	400	414	276	40	55	40	4.85
BO-CF-315-MAX-UK	315	400	414	276	40	55	40	4.85

PERFORMANCE GRAPHS

BO-CF-100-UK

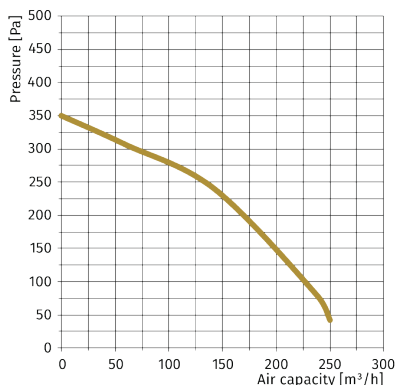

BO-CF-125-UK

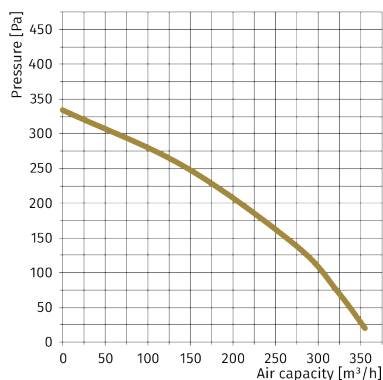

BO-CF-150-UK

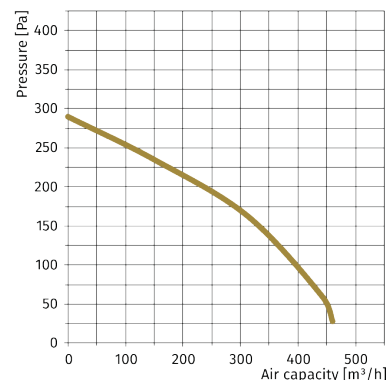

BO-CF-200-UK

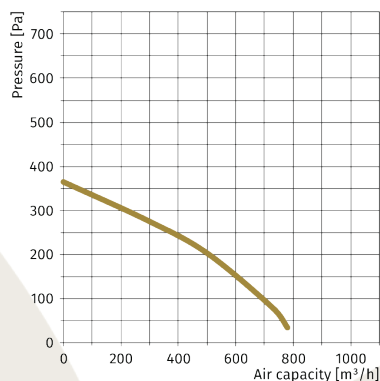

BO-CF-250-UK

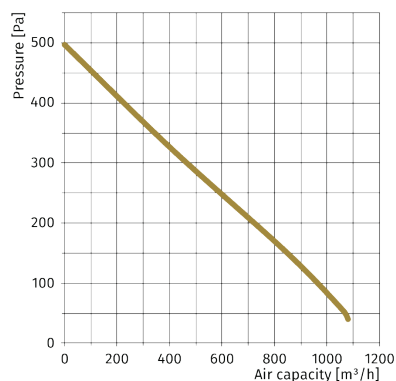

BO-CF-315-UK

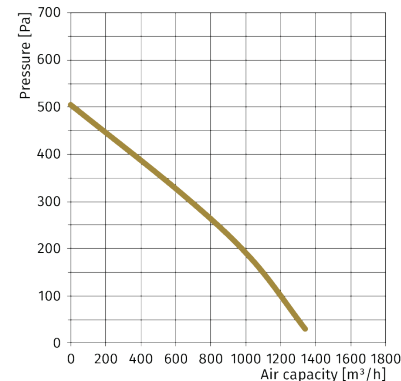

BO-CF-200-MAX-UK

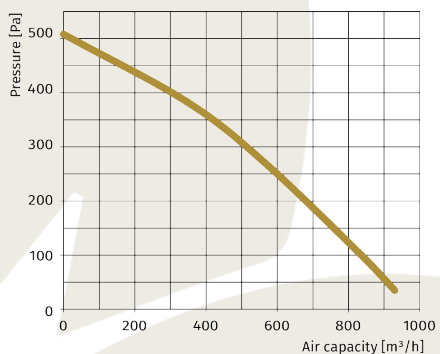

BO-CF-315-MAX-UK

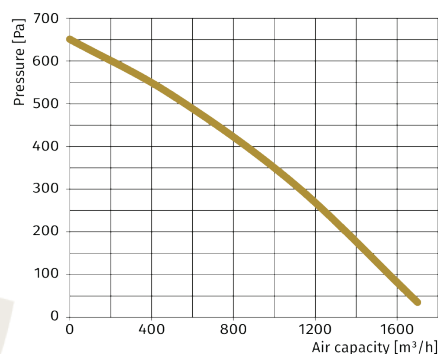

ACCESSORIES

