

SILENT HYBRID-FLO

Black Orchid Silent Hybrid-flo fan with UK plug

The Black Orchid Hybrid-flo combines axial, mixed and centrifugal fan technology to create a fan with high airflow levels and stronger pressure resistances against equipment like carbon filters.

The Silent Hybrid-flo is a variant of the Hybrid-flo, enclosed in a specially designed, sound-insulated polymer coated steel casing. The hybrid impeller and acoustic chamber result in impressively low noise levels, whilst moving high volumes of air.

Its compact design makes Silent Hybrid-flo an ideal solution for mounting in limited spaces that demand big airflows and low noise.

Silent Hybrid-flo features a 2-speed switch, enabling the user to easily control the speed between a low or high speed setting. The fan is also compatible with an external speed controller for full and smooth speed control.



Air flow:
up to 1950 m³/h



Power:
from 24 W



Noise level:
from 23 dB

DESIGN

- The hybrid impeller and aerodynamic casing result in impressive air flow levels.
- The inner perforated casing and sound-absorbing material provide sound attenuation in a broad frequency band.
- Supplied with 1.8m power cable and fitted UK or EU plug.
- Protection rating IPX4 and equipped with overheating protection.
- Single Phase, energy efficient Blauberg German Motor.
- Five year Black Orchid warranty.
- Fitted mounted bracket included.

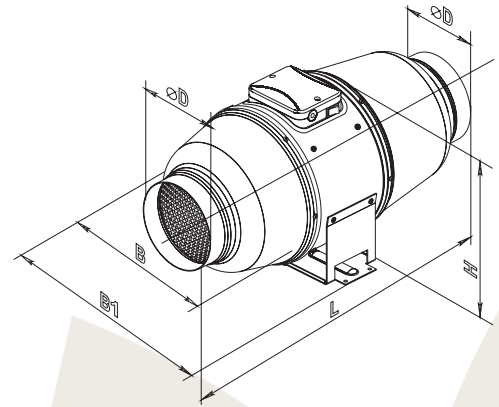

PERFORMANCE

Product	Description	Air Flow [m ³ /h]		Power [W]		Noise Level [dBA]	
		min	max	min	max	min	max
BO-SHF-100-UK	Black Orchid Silent Hybrid-flo 4" Dia c/w 2-speed switch & UK Plug	170	240	24	26	24	29
BO-SHF-125-UK	Black Orchid Silent Hybrid-flo 5" Dia c/w 2-speed switch & UK Plug	230	340	25	29	23	28
BO-SHF-150-UK	Black Orchid Silent Hybrid-flo 6" Dia c/w 2-speed switch & UK Plug	405	555	45	52	26	33
BO-SHF-200-UK	Black Orchid Silent Hybrid-flo 8" Dia c/w 2-speed switch & UK Plug	810	1020	78	110	31	36
BO-SHF-250-UK	Black Orchid Silent Hybrid-flo 10" Dia c/w 2-speed switch & UK Plug	1050	1330	127	178	34	38
BO-SHF-315-UK	Black Orchid Silent Hybrid-flo 12" Dia c/w 2-speed switch & UK Plug	1530	1950	213	313	36	40

DIMENSIONS [MM]

Product	ØD	B	B1	H	L	Weight [kg]
BO-SHF-100-UK	98	215	243	505	237	4.6
BO-SHF-125-UK	123	215	243	474	237	4.6
BO-SHF-150-UK	147	247	274	580	260	6.1
BO-SHF-200-UK	198	293	386	550	295	8
BO-SHF-250-UK	248	358	445	658	360	15
BO-SHF-315-UK	313	432	520	780	434	25

PERFORMANCE GRAPHS

BO-SHF-100-UK

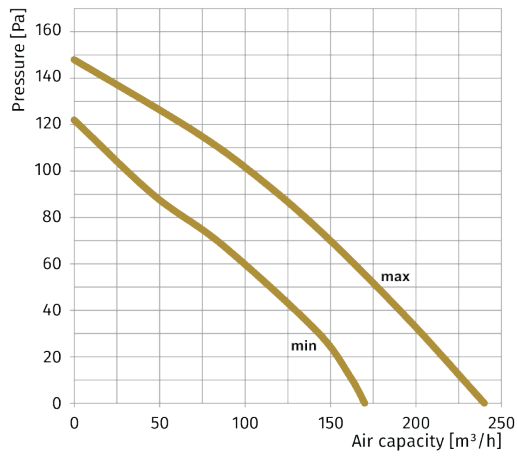

BO-SHF-125-UK

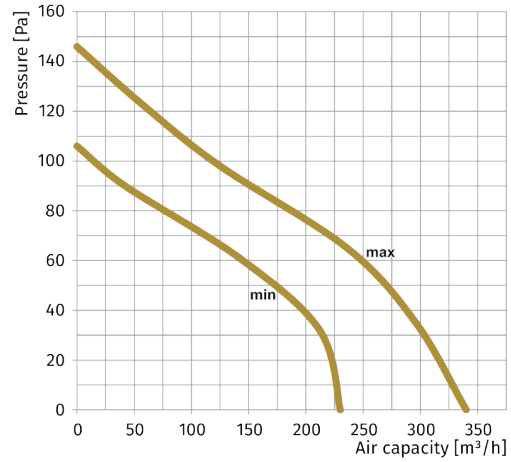

BO-SHF-150-UK

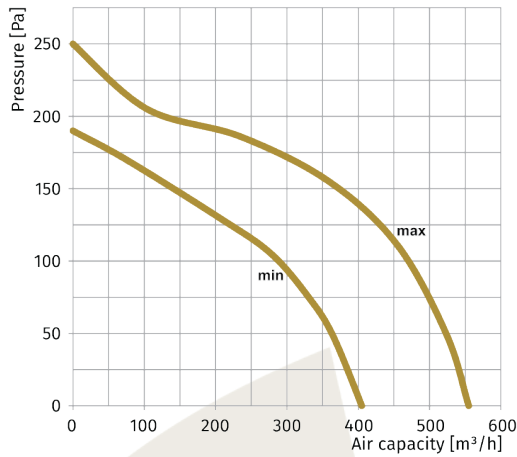

BO-SHF-200-UK

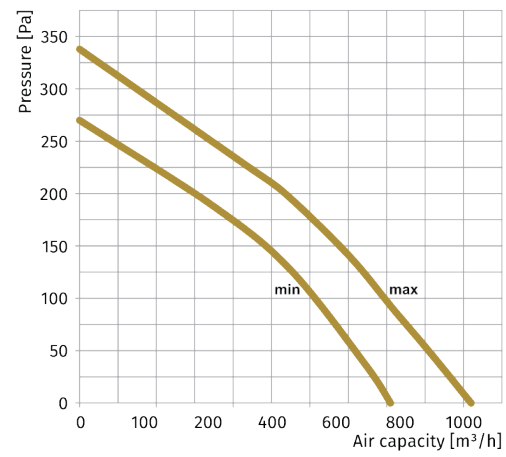

BO-SHF-250-UK

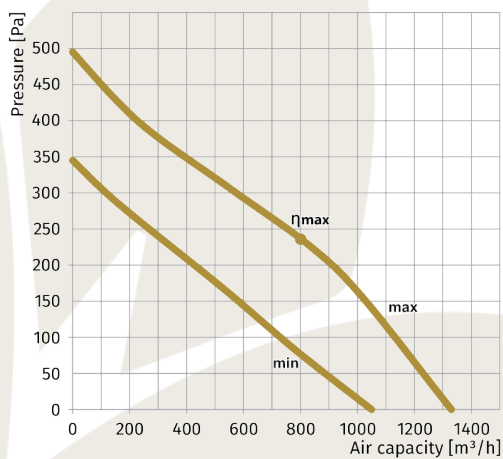

BO-SHF-315-UK

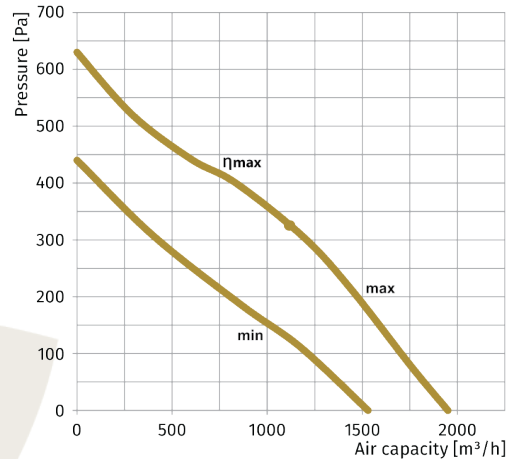

ACCESSORIES

