

BLACK

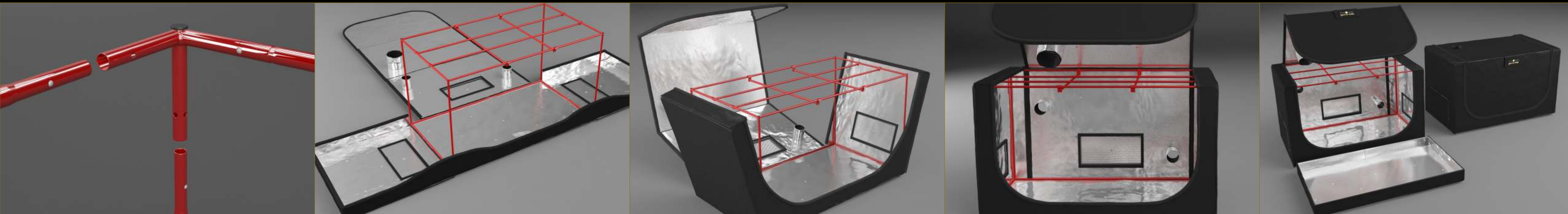

ORCHID™



# Assembly Instruction Manual

for

**Geno-box™**

70cm x 120cm x 70cm

## Box Contents

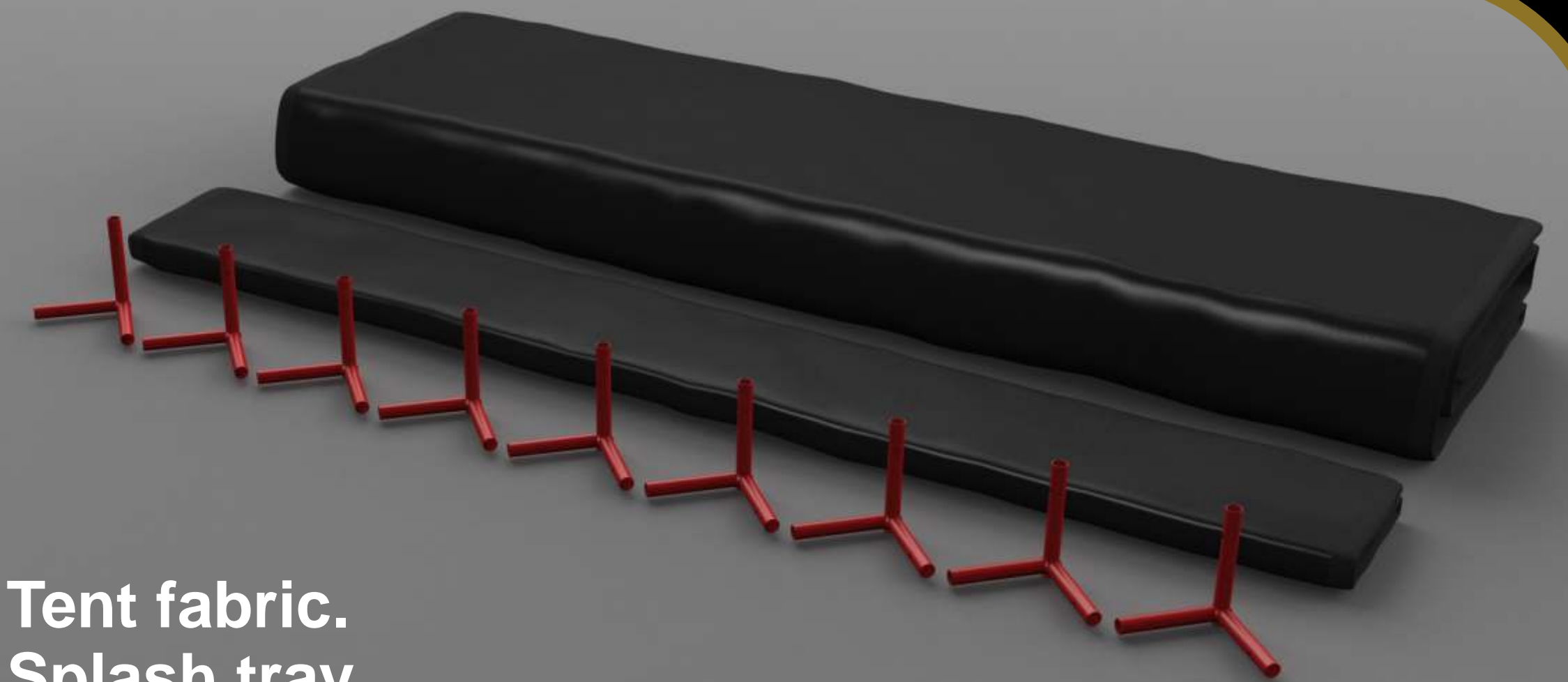

Tent fabric.  
Splash tray.  
Frame corners (including 1 spare):

Please follow the instructions carefully

**Geno-box™**  
Tent Assembly Instructions

STEP

1

'A' Pole - 110cm

'B' Pole - 60cm

Create the frame base by joining 2 A poles and 2 B poles with 4 corner pieces.



Please note the black plastic end caps should be facing upwards when you construct the top of the frame.

**STEP**

**2**

The black plastic end caps should be facing downwards when you construct the base section.

Push the poles into the corner pieces until the locking ball pops through the hole.

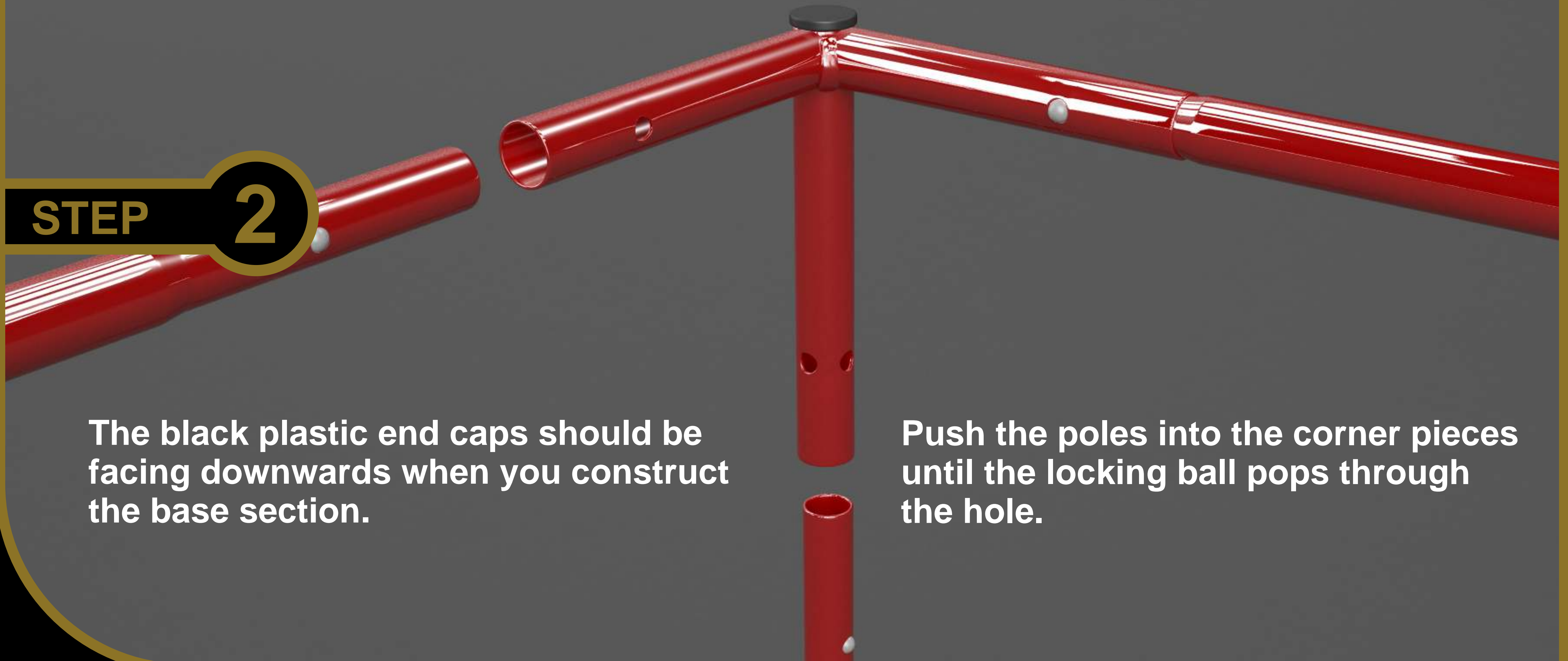

Create the base and the top of the tent frame.

**STEP 3**

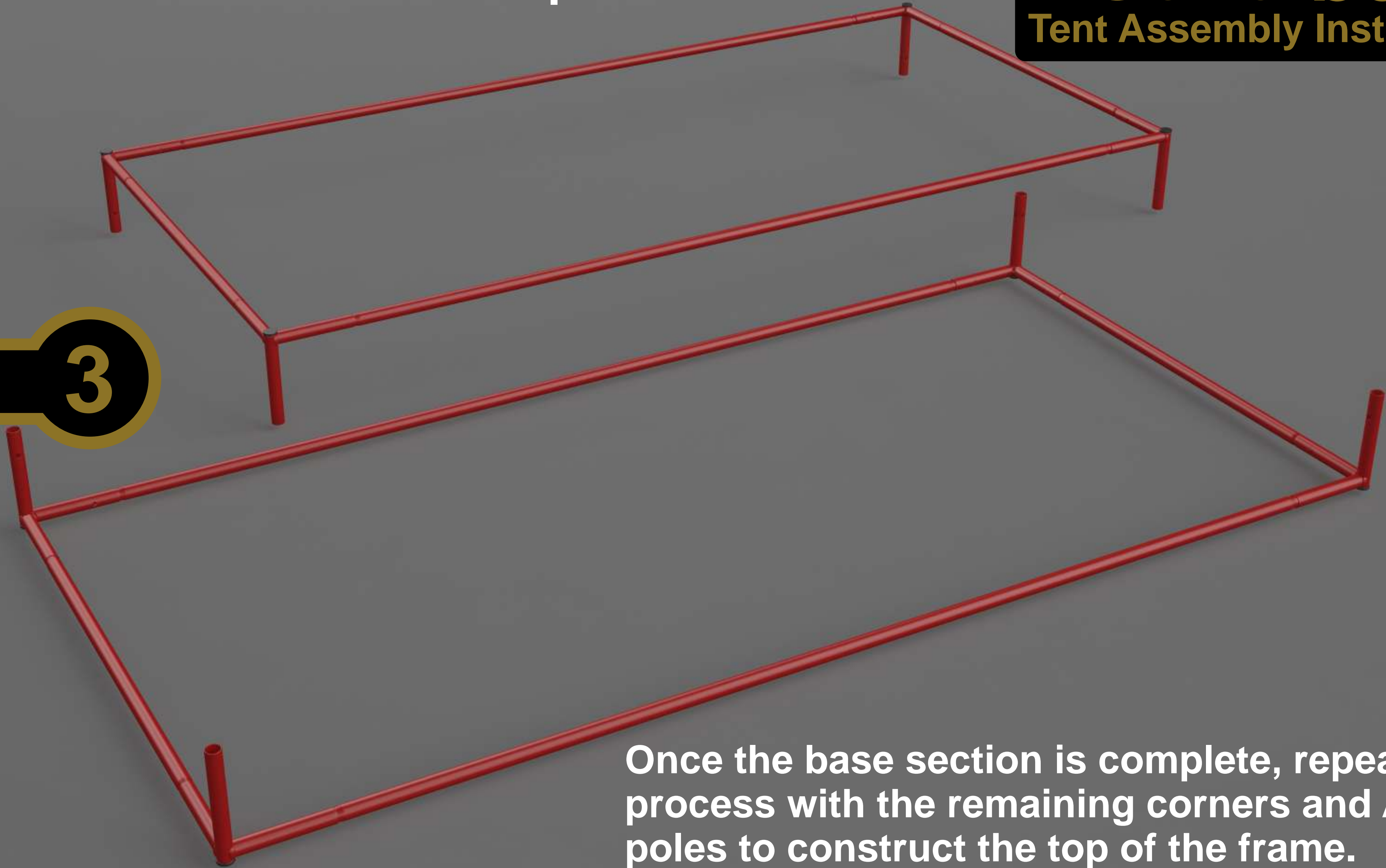

Once the base section is complete, repeat the process with the remaining corners and A and B poles to construct the top of the frame.



'C' Poles

Top Frame

STEP

4

Add poles C to the base section.

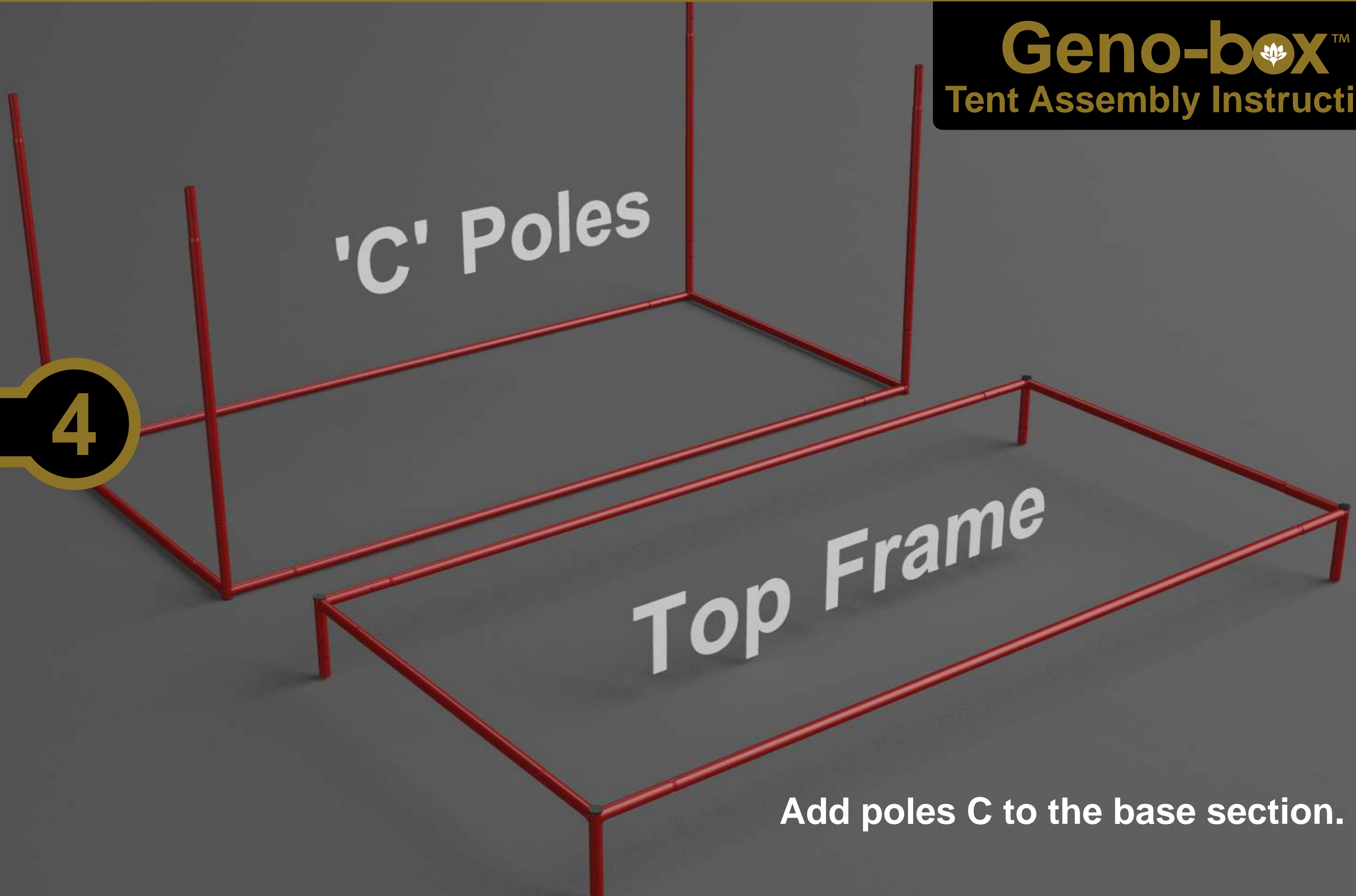

**STEP**

**5**

**'C' Pole - 60cm**

Join together the base of the frame with  
the top of the frame.

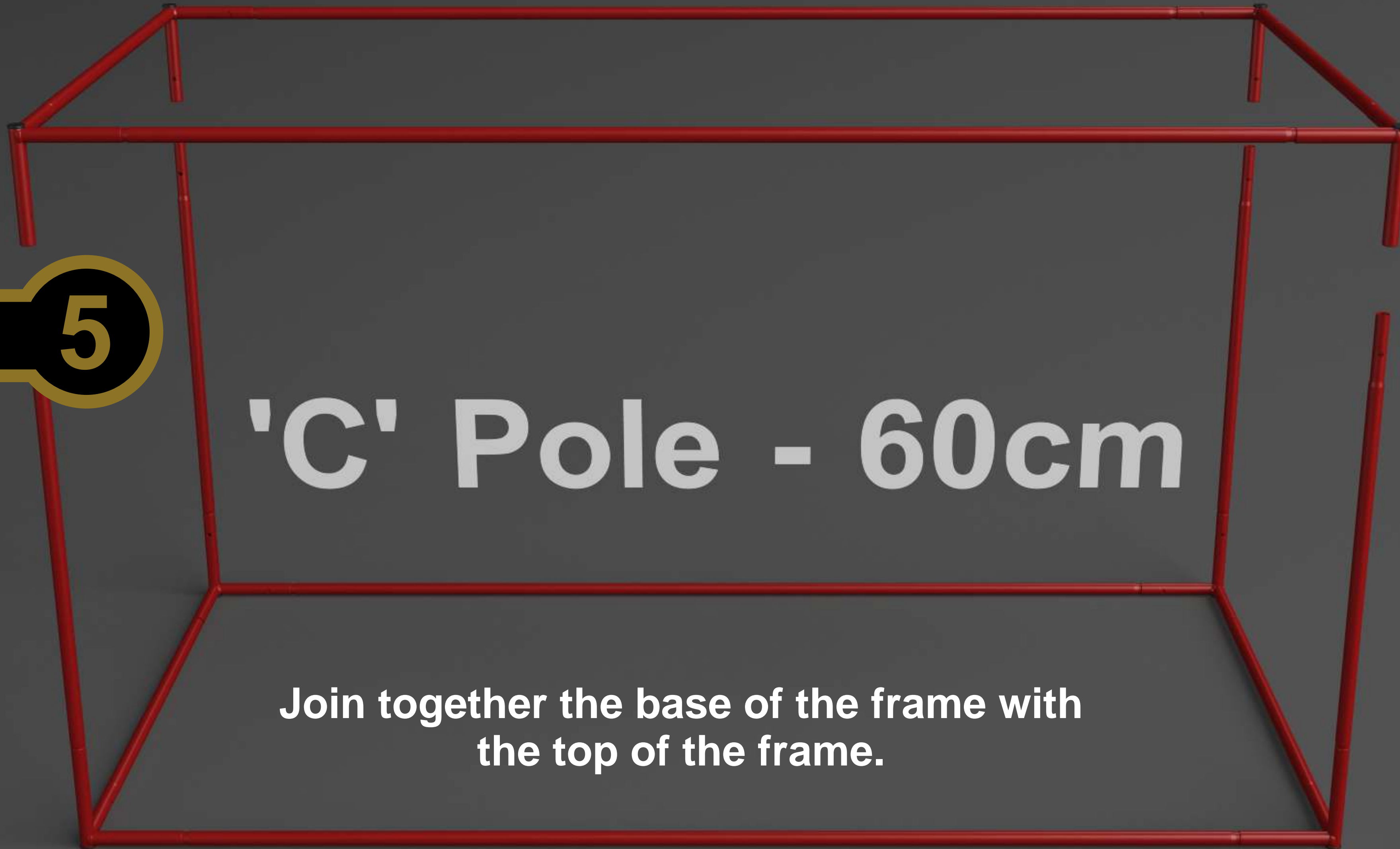



**Geno-box™**  
Tent Assembly Instructions

**STEP**

**6**

Add poles D and E to the top of the frame.

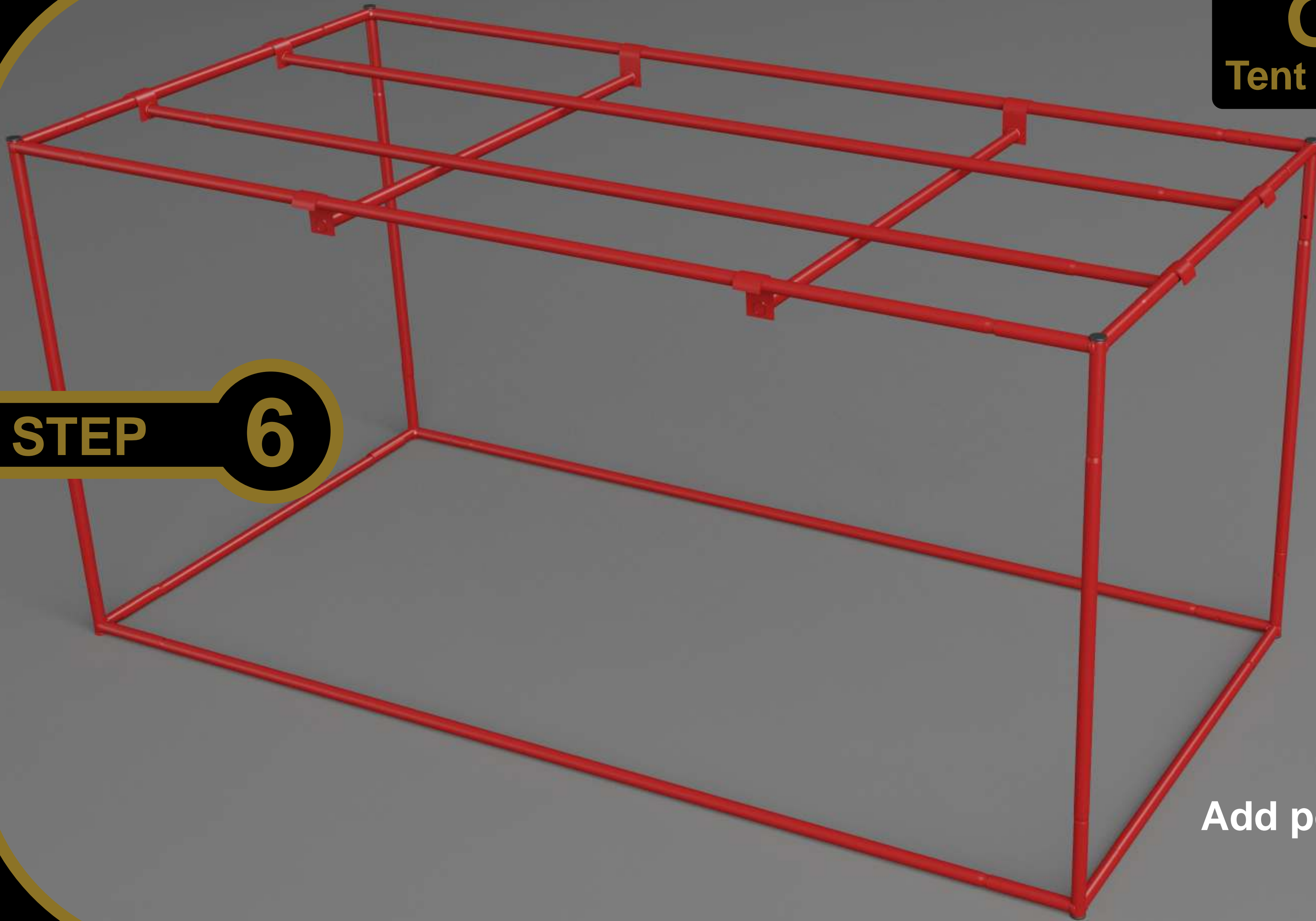



# Geno-box™

## Tent Assembly Instructions

STEP

7

Unfold your tent and place the frame into the base as pictured.

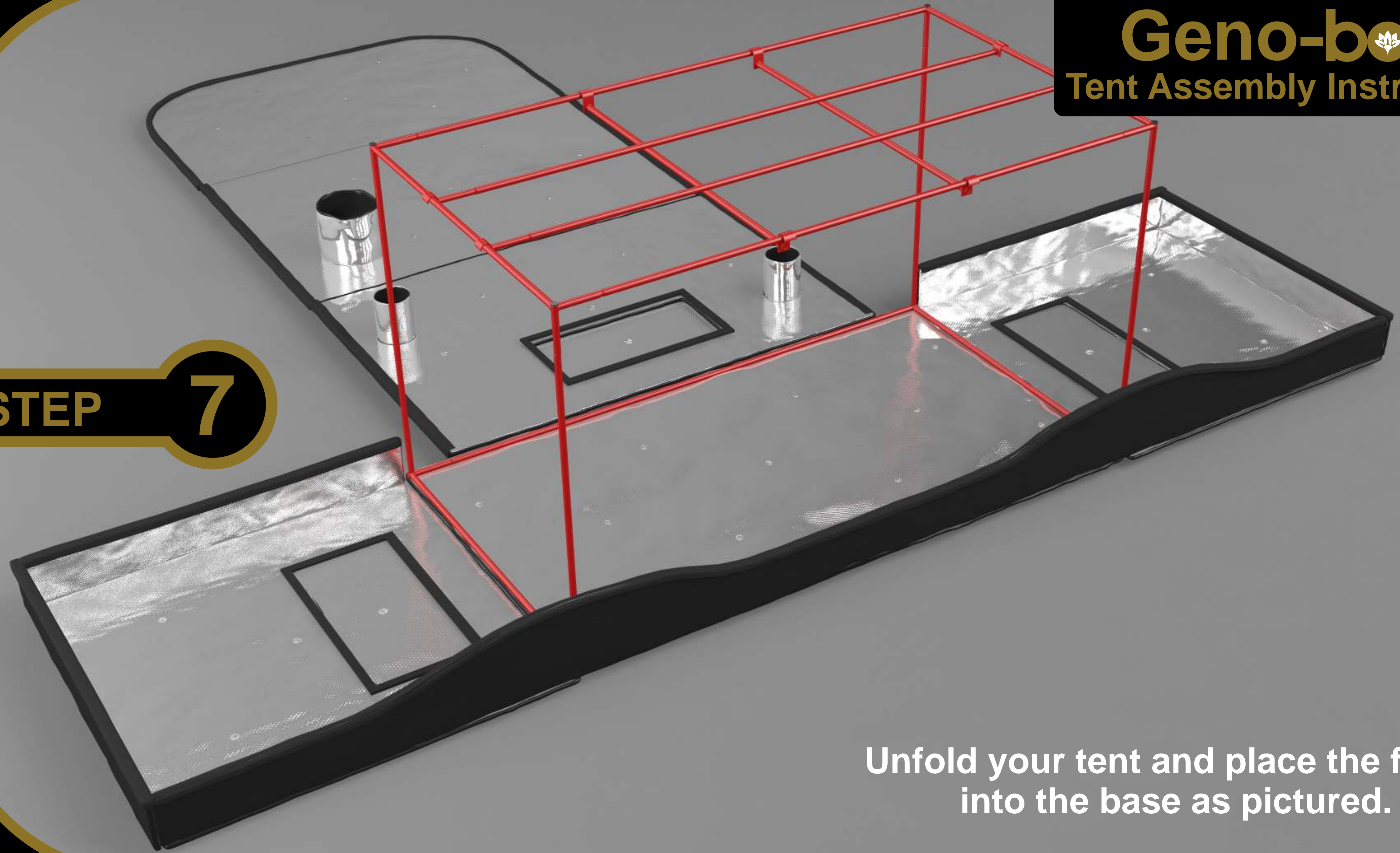



# Geno-box™

## Tent Assembly Instructions

STEP

8

Make sure the bottom of the tent is fitted firmly around the frame before lifting the top of the tent on to the frame.

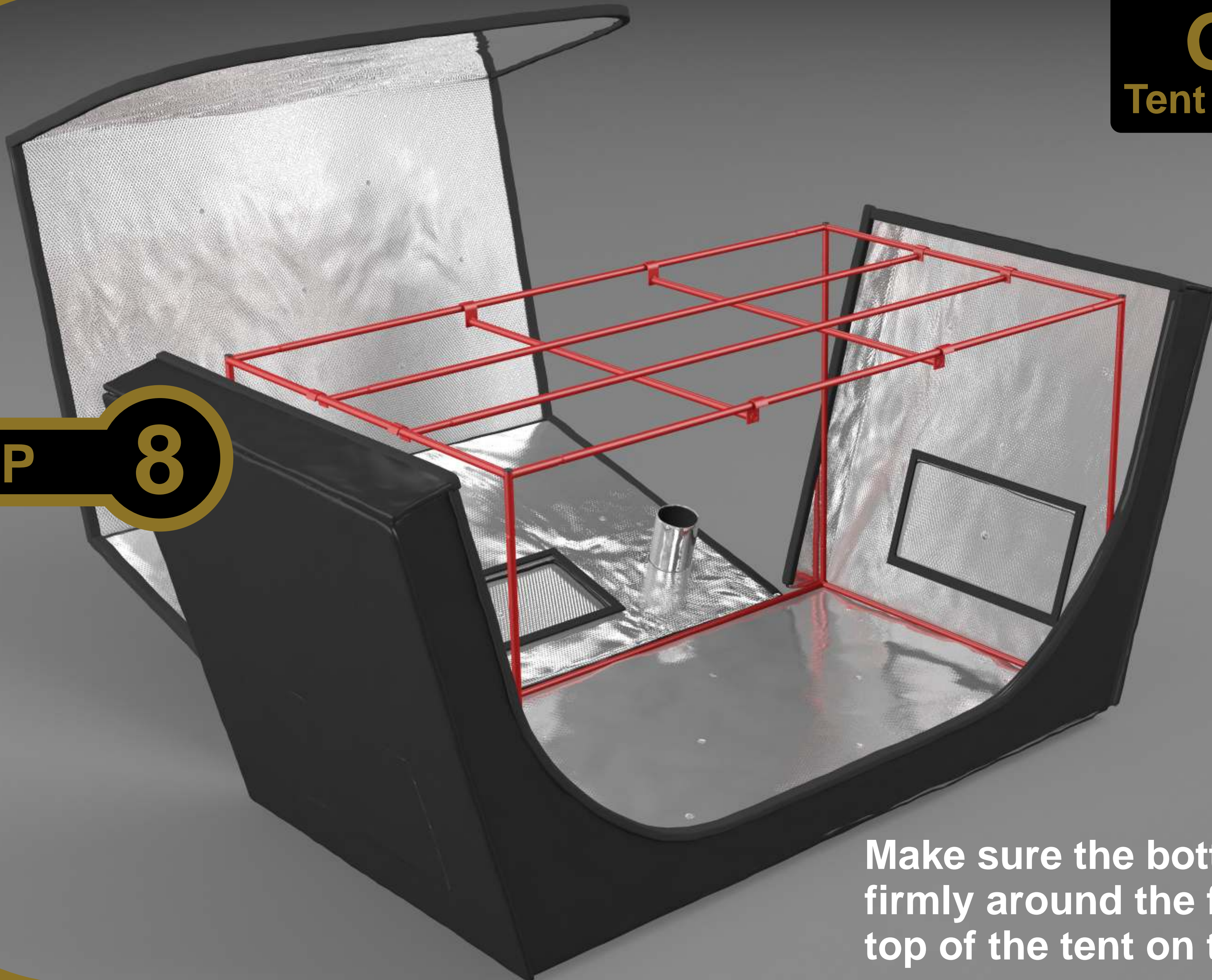



BLACK ORCHID  
geno-box

Lift the top of the tent fabric and carefully fit it around the top of the frame.

STEP

9

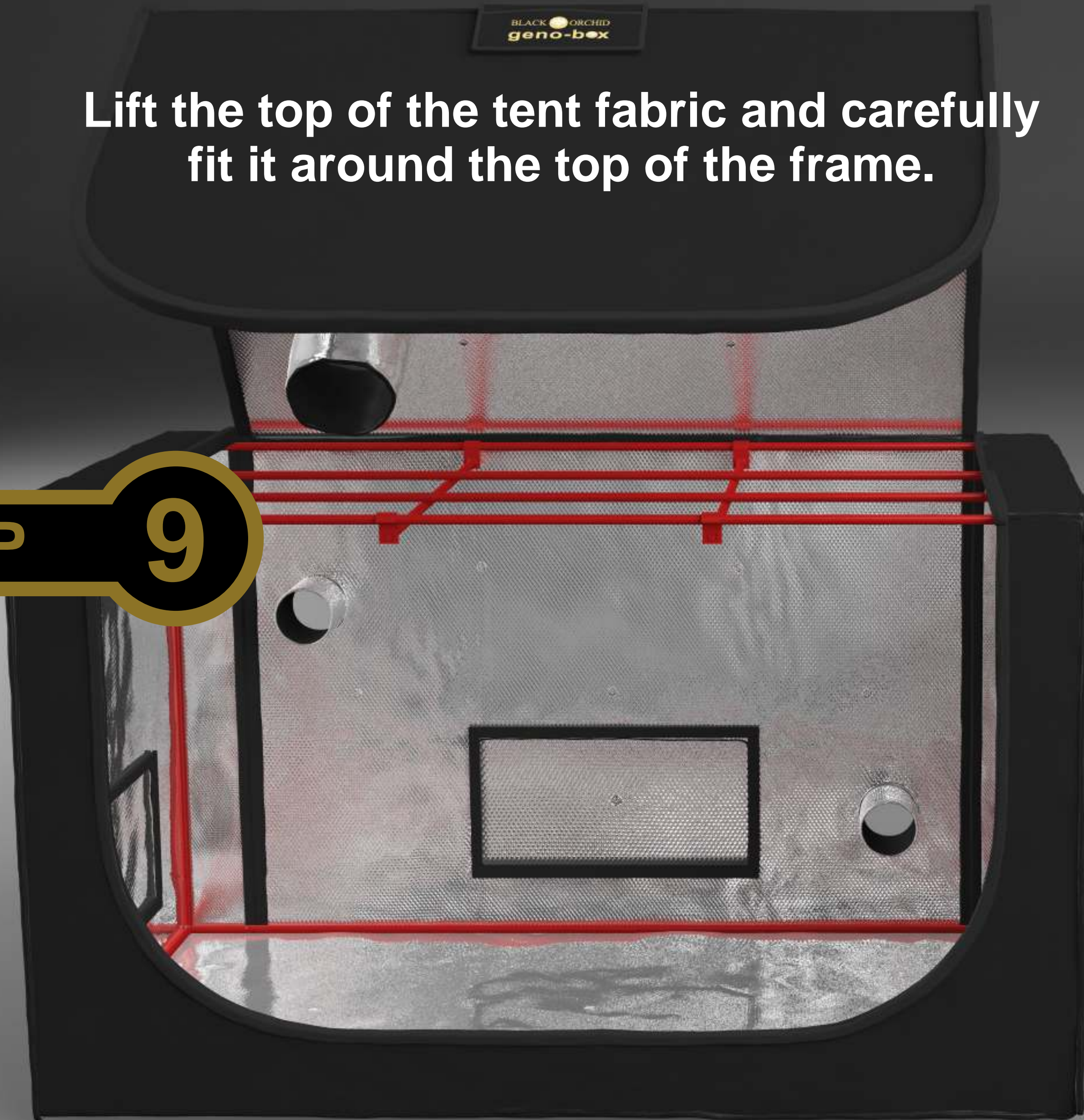

# Geno-box™

## Tent Assembly Instructions



Now, zip both the top and bottom zips to meet at the front of the tent.



# Geno-box™

## Tent Assembly Instructions

STEP

10

Add the splash tray  
once complete.

